

Q. 1 – Q. 25 carry one mark each.

Q.1 The bilateral Laplace transform of a function $f(t) = \begin{cases} 1 & \text{if } a \leq t \leq b \\ 0 & \text{otherwise} \end{cases}$

is

- (A) $\frac{a-b}{s}$ (B) $\frac{e^s(a-b)}{s}$ (C) $\frac{e^{-as} - e^{-bs}}{s}$ (D) $\frac{e^{s(a-b)}}{s}$

Q.2 The value of x for which all the eigen-values of the matrix given below are real is

$$\begin{bmatrix} 10 & 5+j & 4 \\ x & 20 & 2 \\ 4 & 2 & -10 \end{bmatrix}$$

- (A) $5 + j$ (B) $5 - j$ (C) $1 - 5j$ (D) $1 + 5j$

Q.3 Let $f(z) = \frac{az+b}{cz+d}$. If $f(z_1) = f(z_2)$ for all $z_1 \neq z_2$, $a = 2, b = 4$ and $c = 5$, then d should be equal to _____.

Q.4 The general solution of the differential equation $\frac{dy}{dx} = \frac{1 + \cos 2y}{1 - \cos 2x}$ is

- (A) $\tan y - \cot x = c$ (c is a constant) (B) $\tan x - \cot y = c$ (c is a constant)
 (C) $\tan y + \cot x = c$ (c is a constant) (D) $\tan x + \cot y = c$ (c is a constant)

Q.5 The magnitude and phase of the complex Fourier series coefficients a_k of a periodic signal $x(t)$ are shown in the figure. Choose the correct statement from the four choices given. Notation: C is the set of complex numbers, R is the set of purely real numbers, and P is the set of purely imaginary numbers.

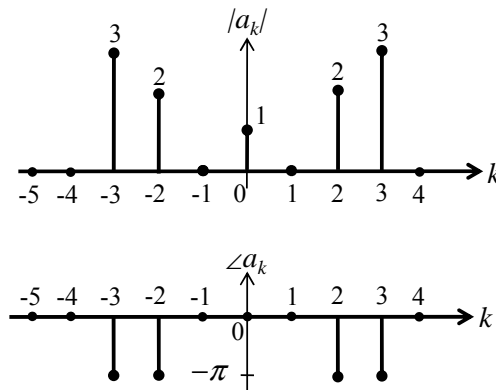

- (A) $x(t) \in R$
 (B) $x(t) \in P$
 (C) $x(t) \in (C - R)$
 (D) the information given is not sufficient to draw any conclusion about $x(t)$

Q.6 The voltage (V_C) across the capacitor (in Volts) in the network shown is _____ .

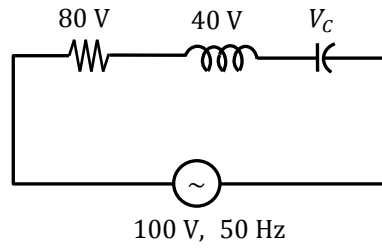

Q.7 In the circuit shown, the *average* value of the voltage V_{ab} (in Volts) in steady state condition is _____ .

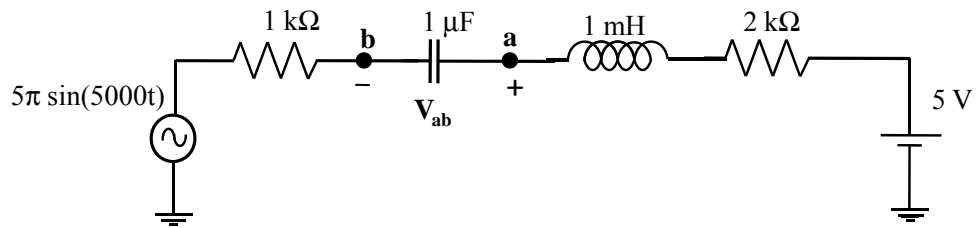

Q.8 The 2-port admittance matrix of the circuit shown is given by

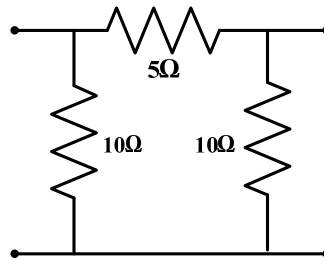

(A) $\begin{bmatrix} 0.3 & 0.2 \\ 0.2 & 0.3 \end{bmatrix}$

(B) $\begin{bmatrix} 15 & 5 \\ 5 & 15 \end{bmatrix}$

(C) $\begin{bmatrix} 3.33 & 5 \\ 5 & 3.33 \end{bmatrix}$

(D) $\begin{bmatrix} 0.3 & 0.4 \\ 0.4 & 0.3 \end{bmatrix}$

Q.9 An n-type silicon sample is uniformly illuminated with light which generates 10^{20} electron-hole pairs per cm^3 per second. The minority carrier lifetime in the sample is $1 \mu\text{s}$. In the steady state, the hole concentration in the sample is approximately 10^x , where x is an integer. The value of x is ____.

Q.10 A piece of silicon is doped uniformly with phosphorous with a doping concentration of $10^{16}/\text{cm}^3$. The expected value of mobility versus doping concentration for silicon assuming full dopant ionization is shown below. The charge of an electron is 1.6×10^{-19} C. The conductivity (in S cm^{-1}) of the silicon sample at 300 K is _____.

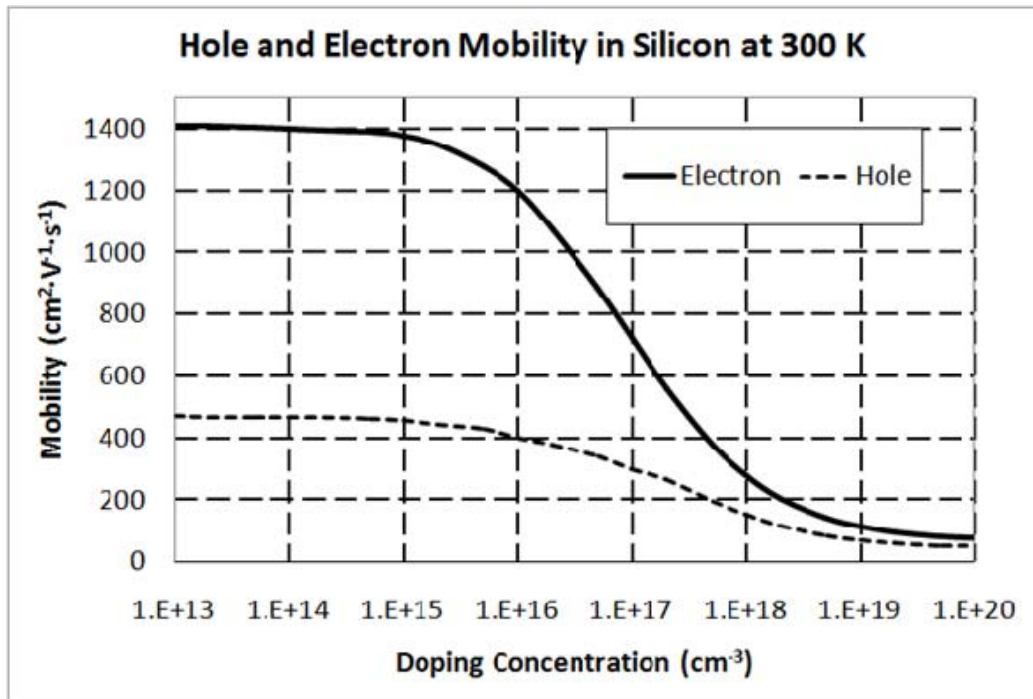

Q.11 If the circuit shown has to function as a clamping circuit, then which one of the following conditions should be satisfied for the sinusoidal signal of period T ?

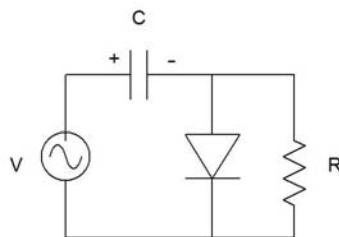

- (A) $RC \ll T$
- (B) $RC = 0.35 T$
- (C) $RC \approx T$
- (D) $RC \gg T$

Q.12 In the circuit shown, $V_0 = V_{0A}$ for switch SW in position A and $V_0 = V_{0B}$ for SW in position B. Assume that the opamp is ideal. The value of $\frac{V_{0B}}{V_{0A}}$ is _____.

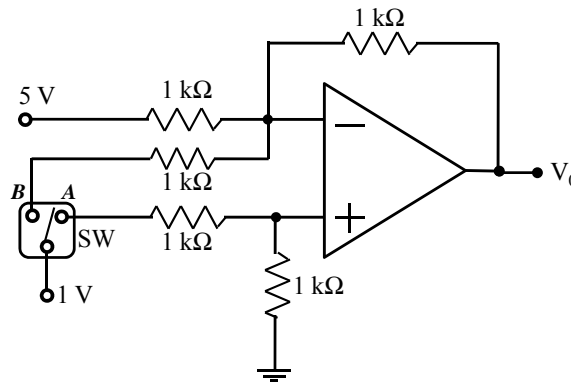

Q.13 In the bistable circuit shown, the ideal opamp has saturation levels of ± 5 V. The value of R_1 (in kΩ) that gives a hysteresis width of 500 mV is _____.

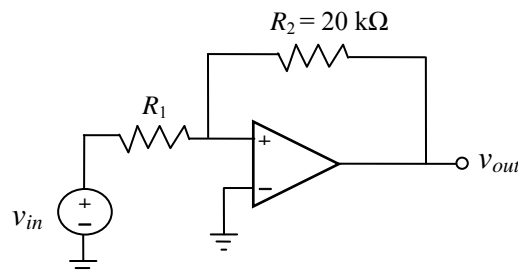

Q.14 In the figure shown, the output Y is required to be $Y = A B + \bar{C} \bar{D}$. The gates G1 and G2 must be, respectively,

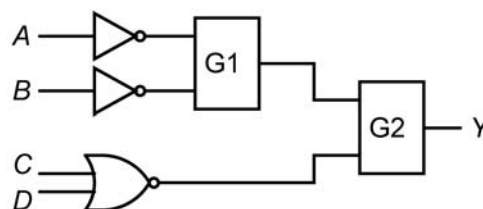

- (A) NOR, OR
- (B) OR, NAND
- (C) NAND, OR
- (D) AND, NAND

Q.15 In an 8085 microprocessor, which one of the following instructions changes the content of the accumulator?

- (A) MOV B,M
- (B) PCHL
- (C) RNZ
- (D) SBI BEH

- Q.16 A mod- n counter using a synchronous binary up-counter with synchronous clear input is shown in the figure. The value of n is _____.

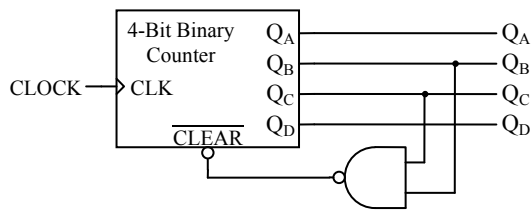

- Q.17 Let the signal $f(t) = 0$ outside the interval $[T_1, T_2]$, where T_1 and T_2 are finite. Furthermore, $|f(t)| < \infty$. The region of convergence (RoC) of the signal's bilateral Laplace transform $F(s)$ is

- (A) a parallel strip containing the $j\Omega$ axis
 (B) a parallel strip not containing the $j\Omega$ axis
 (C) the entire s -plane
 (D) a half plane containing the $j\Omega$ axis

- Q.18 Two causal discrete-time signals $x[n]$ and $y[n]$ are related as $y[n] = \sum_{m=0}^n x[m]$.

If the z -transform of $y[n]$ is $\frac{2}{z(z-1)^2}$, the value of $x[2]$ is _____.

- Q.19 By performing cascading and/or summing/differencing operations using transfer function blocks $G_1(s)$ and $G_2(s)$, one **CANNOT** realize a transfer function of the form

(A) $G_1(s)G_2(s)$

(B) $\frac{G_1(s)}{G_2(s)}$

(C) $G_1(s) \left(\frac{1}{G_1(s)} + G_2(s) \right)$

(D) $G_1(s) \left(\frac{1}{G_1(s)} - G_2(s) \right)$

- Q.20 For the signal flow graph shown in the figure, the value of $\frac{C(s)}{R(s)}$ is

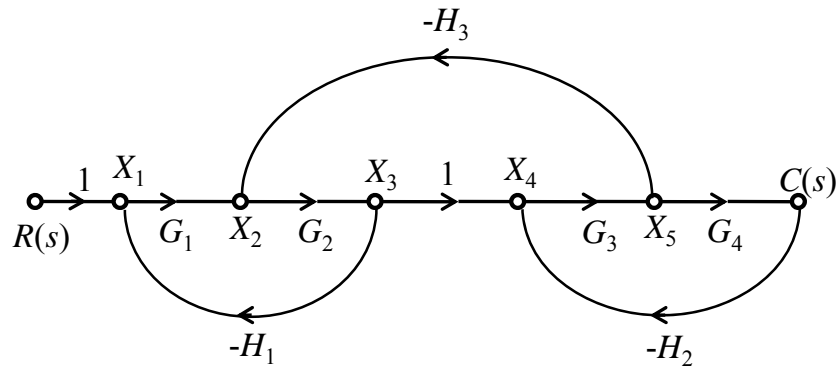

- (A) $\frac{G_1 G_2 G_3 G_4}{1 - G_1 G_2 H_1 - G_3 G_4 H_2 - G_2 G_3 H_3 + G_1 G_2 G_3 G_4 H_1 H_2}$
- (B) $\frac{G_1 G_2 G_3 G_4}{1 + G_1 G_2 H_1 + G_3 G_4 H_2 + G_2 G_3 H_3 + G_1 G_2 G_3 G_4 H_1 H_2}$
- (C) $\frac{1}{1 + G_1 G_2 H_1 + G_3 G_4 H_2 + G_2 G_3 H_3 + G_1 G_2 G_3 G_4 H_1 H_2}$
- (D) $\frac{1}{1 - G_1 G_2 H_1 - G_3 G_4 H_2 - G_2 G_3 H_3 + G_1 G_2 G_3 G_4 H_1 H_2}$
- Q.21 A unity negative feedback system has an open-loop transfer function $G(s) = \frac{K}{s(s+10)}$. The gain K for the system to have a damping ratio of 0.25 is _____.
- Q.22 A sinusoidal signal of amplitude A is quantized by a uniform quantizer. Assume that the signal utilizes all the representation levels of the quantizer. If the signal to quantization noise ratio is 31.8 dB, the number of levels in the quantizer is _____.
- Q.23 The signal $\cos\left(10\pi t + \frac{\pi}{4}\right)$ is ideally sampled at a sampling frequency of 15 Hz. The sampled signal is passed through a filter with impulse response $\left(\frac{\sin(\pi t)}{\pi t}\right)\cos\left(40\pi t - \frac{\pi}{2}\right)$. The filter output is
- (A) $\frac{15}{2}\cos\left(40\pi t - \frac{\pi}{4}\right)$
- (B) $\frac{15}{2}\left(\frac{\sin(\pi t)}{\pi t}\right)\cos\left(10\pi t + \frac{\pi}{4}\right)$
- (C) $\frac{15}{2}\cos\left(10\pi t - \frac{\pi}{4}\right)$
- (D) $\frac{15}{2}\left(\frac{\sin(\pi t)}{\pi t}\right)\cos\left(40\pi t - \frac{\pi}{2}\right)$

Q.24 In a source free region in vacuum, if the electrostatic potential $\varphi = 2x^2 + y^2 + cz^2$, the value of constant c must be _____.

Q.25 The electric field of a uniform plane electromagnetic wave is

$$\vec{E} = (\vec{a}_x + j4\vec{a}_y) \exp[j(2\pi \times 10^7 t - 0.2z)].$$

The polarization of the wave is

(A) right handed circular

(B) right handed elliptical

(C) left handed circular

(D) left handed elliptical

Q. 26 – Q. 55 carry two marks each.

Q.26 Consider the differential equation $\frac{dx}{dt} = 10 - 0.2x$ with initial condition $x(0) = 1$. The response $x(t)$ for $t > 0$ is

(A) $2 - e^{-0.2t}$

(B) $2 - e^{0.2t}$

(C) $50 - 49e^{-0.2t}$

(D) $50 - 49e^{0.2t}$

Q.27 The value of the integral $\int_{-\infty}^{\infty} 12 \cos(2\pi t) \frac{\sin(4\pi t)}{4\pi t} dt$ is _____.

Q.28 If C denotes the counterclockwise unit circle, the value of the contour integral

$$\frac{1}{2\pi j} \oint_C \operatorname{Re}\{z\} dz$$

is _____.

Q.29 Let the random variable X represent the number of times a fair coin needs to be tossed till two consecutive heads appear for the first time. The expectation of X is _____.

Q.30 An LC tank circuit consists of an ideal capacitor C connected in parallel with a coil of inductance L having an internal resistance R . The resonant frequency of the tank circuit is

(A) $\frac{1}{2\pi\sqrt{LC}}$

(B) $\frac{1}{2\pi\sqrt{LC}} \sqrt{1 - R^2 \frac{C}{L}}$

(C) $\frac{1}{2\pi\sqrt{LC}} \sqrt{1 - \frac{L}{R^2 C}}$

(D) $\frac{1}{2\pi\sqrt{LC}} \left(1 - R^2 \frac{C}{L}\right)$

Q.31 In the circuit shown, the Norton equivalent resistance (in Ω) across terminals a-b is _____.

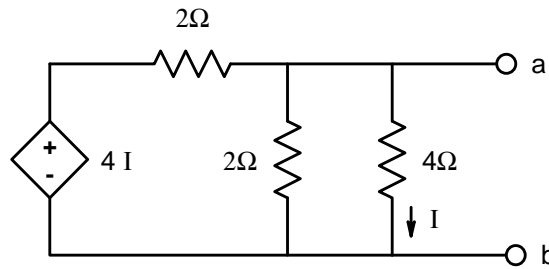

Q.32 In the circuit shown, the initial voltages across the capacitors C_1 and C_2 are 1 V and 3 V, respectively. The switch is closed at time $t = 0$. The total energy dissipated (in Joules) in the resistor R until steady state is reached, is _____.

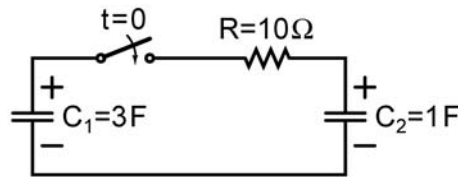

Q.33 A dc voltage of 10 V is applied across an n-type silicon bar having a rectangular cross-section and a length of 1 cm as shown in figure. The donor doping concentration N_D and the mobility of electrons μ_n are 10^{16} cm^{-3} and $1000 \text{ cm}^2\text{V}^{-1}\text{s}^{-1}$, respectively. The average time (in μs) taken by the electrons to move from one end of the bar to other end is _____.

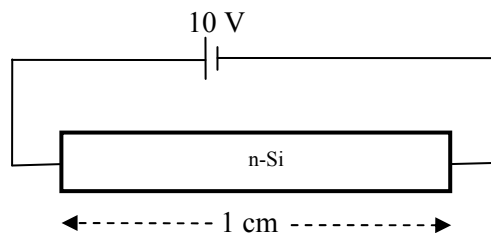

Q.34 In a MOS capacitor with an oxide layer thickness of 10 nm, the maximum depletion layer thickness is 100 nm. The permittivities of the semiconductor and the oxide layer are ϵ_s and ϵ_{ox} respectively. Assuming $\epsilon_s/\epsilon_{ox} = 3$, the ratio of the maximum capacitance to the minimum capacitance of this MOS capacitor is _____.

Q.35 The energy band diagram and the electron density profile $n(x)$ in a semiconductor are shown in the figures. Assume that $n(x) = 10^{15} e^{\left(\frac{q\alpha x}{kT}\right)} \text{ cm}^{-3}$, with $\alpha = 0.1 \text{ V/cm}$ and x expressed in cm. Given $\frac{kT}{q} = 0.026 \text{ V}$, $D_n = 36 \text{ cm}^2\text{s}^{-1}$, and $\frac{D}{\mu} = \frac{kT}{q}$. The electron current density (in A/cm^2) at $x = 0$ is

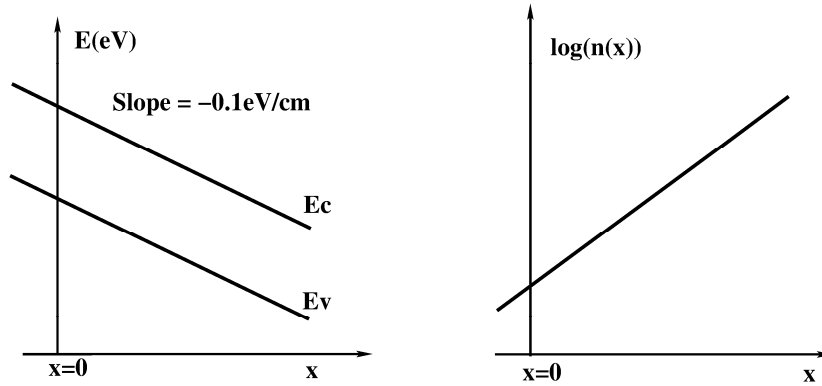

- (A) -4.4×10^{-2} (B) -2.2×10^{-2} (C) 0 (D) 2.2×10^{-2}

Q.36 A function of Boolean variables X, Y and Z is expressed in terms of the min-terms as

$$F(X, Y, Z) = \Sigma (1, 2, 5, 6, 7)$$

Which one of the product of sums given below is equal to the function $F(X, Y, Z)$?

- (A) $(\bar{X} + \bar{Y} + \bar{Z}) \cdot (\bar{X} + Y + Z) \cdot (X + \bar{Y} + \bar{Z})$
 (B) $(X + Y + Z) \cdot (X + \bar{Y} + \bar{Z}) \cdot (\bar{X} + Y + Z)$
 (C) $(\bar{X} + \bar{Y} + Z) \cdot (\bar{X} + Y + \bar{Z}) \cdot (X + \bar{Y} + Z) \cdot (X + Y + \bar{Z}) \cdot (X + Y + Z)$
 (D) $(X + Y + \bar{Z}) \cdot (\bar{X} + Y + Z) \cdot (\bar{X} + Y + \bar{Z}) \cdot (\bar{X} + \bar{Y} + Z) \cdot (\bar{X} + \bar{Y} + \bar{Z})$

Q.37 The figure shows a binary counter with synchronous clear input. With the decoding logic shown, the counter works as a

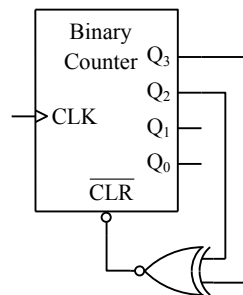

- (A) mod-2 counter (B) mod-4 counter (C) mod-5 counter (D) mod-6 counter

Q.38 A 1-to-8 demultiplexer with data input D_{in} , address inputs S_0, S_1, S_2 (with S_0 as the LSB) and \bar{Y}_0 to \bar{Y}_7 as the eight demultiplexed outputs, is to be designed using two 2-to-4 decoders (with enable input \bar{E} and address inputs A_0 and A_1) as shown in the figure. D_{in}, S_0, S_1 and S_2 are to be connected to P, Q, R and S, but not necessarily in this order. The respective input connections to P, Q, R, and S terminals should be

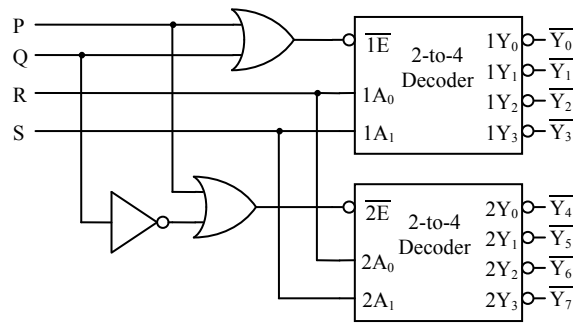

- (A) S_2, D_{in}, S_0, S_1
- (B) S_1, D_{in}, S_0, S_2
- (C) D_{in}, S_0, S_1, S_2
- (D) D_{in}, S_2, S_0, S_1

Q.39 The diode in the circuit given below has $V_{ON} = 0.7 V$ but is ideal otherwise. The current (in mA) in the $4 k\Omega$ resistor is _____.

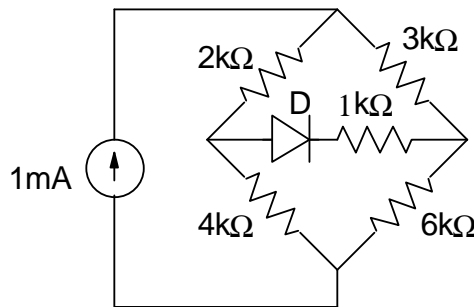

Q.40 Assuming that the opamp in the circuit shown below is ideal, the output voltage V_o (in volts) is _____.

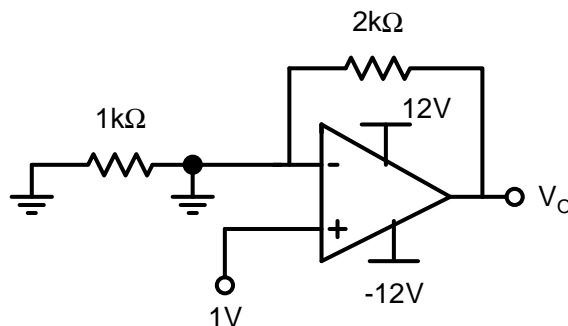

- Q.41 For the voltage regulator circuit shown, the input voltage (V_{in}) is $20\text{ V} \pm 20\%$ and the regulated output voltage (V_{out}) is 10 V . Assume the opamp to be ideal. For a load R_L drawing 200 mA , the maximum power dissipation in Q_1 (in Watts) is _____.

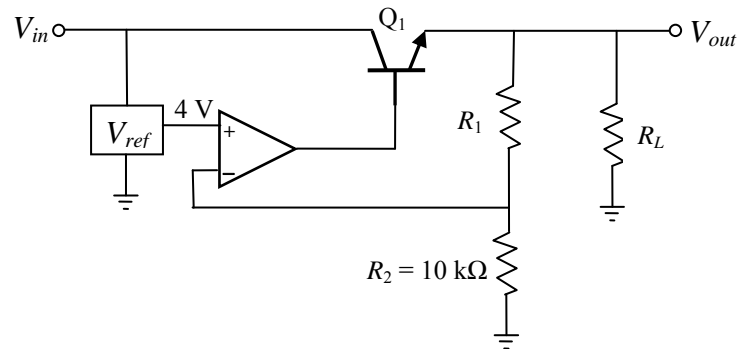

- Q.42 In the ac equivalent circuit shown, the two BJTs are biased in active region and have identical parameters with $\beta \gg 1$. The open circuit small signal voltage gain is approximately _____.

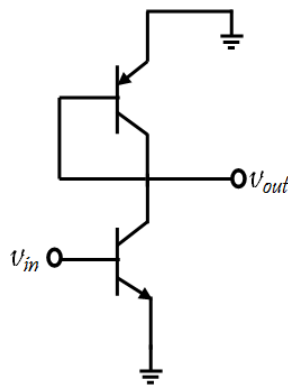

- Q.43 Input $x(t)$ and output $y(t)$ of an LTI system are related by the differential equation $y''(t) - y'(t) - 6y(t) = x(t)$. If the system is neither causal nor stable, the impulse response $h(t)$ of the system is

- (A) $\frac{1}{5}e^{3t}u(-t) + \frac{1}{5}e^{-2t}u(-t)$ (B) $-\frac{1}{5}e^{3t}u(-t) + \frac{1}{5}e^{-2t}u(-t)$
 (C) $\frac{1}{5}e^{3t}u(-t) - \frac{1}{5}e^{-2t}u(t)$ (D) $-\frac{1}{5}e^{3t}u(-t) - \frac{1}{5}e^{-2t}u(t)$

Q.44 Consider two real sequences with time-origin marked by the bold value,

$$x_1[n] = \{\mathbf{1}, 2, 3, 0\}, \quad x_2[n] = \{\mathbf{1}, 3, 2, 1\}$$

Let $X_1(k)$ and $X_2(k)$ be 4-point DFTs of $x_1[n]$ and $x_2[n]$, respectively.

Another sequence $x_3[n]$ is derived by taking 4-point inverse DFT of $X_3(k) = X_1(k)X_2(k)$.

The value of $x_3[2]$ is _____.

Q.45 Let $x(t) = \alpha s(t) + s(-t)$ with $s(t) = \beta e^{-4t}u(t)$, where $u(t)$ is unit step function. If the bilateral Laplace transform of $x(t)$ is

$$X(s) = \frac{16}{s^2 - 16} \quad -4 < \operatorname{Re}\{s\} < 4;$$

then the value of β is _____.

Q.46 The state variable representation of a system is given as

$$\dot{x} = \begin{bmatrix} 0 & 1 \\ 0 & -1 \end{bmatrix} x; \quad x(0) = \begin{bmatrix} 1 \\ 0 \end{bmatrix}$$

$$y = [0 \quad 1]x$$

The response $y(t)$ is

- (A) $\sin(t)$ (B) $1 - e^t$ (C) $1 - \cos(t)$ (D) 0

Q.47 The output of a standard second-order system for a unit step input is given as

$$y(t) = 1 - \frac{2}{\sqrt{3}} e^{-t} \cos\left(\sqrt{3}t - \frac{\pi}{6}\right). \quad \text{The transfer function of the system is}$$

- (A) $\frac{2}{(s+2)(s+\sqrt{3})}$ (B) $\frac{1}{s^2 + 2s + 1}$ (C) $\frac{3}{s^2 + 2s + 3}$ (D) $\frac{4}{s^2 + 2s + 4}$

Q.48 The transfer function of a mass-spring-damper system is given by

$$G(s) = \frac{1}{Ms^2 + Bs + K}$$

The frequency response data for the system are given in the following table.

ω in rad/s	$ G(j\omega) $ in dB	$\arg(G(j\omega))$ in deg
0.01	-18.5	-0.2
0.1	-18.5	-1.3
0.2	-18.4	-2.6
1	-16	-16.9
2	-11.4	-89.4
3	-21.5	-151
5	-32.8	-167
10	-45.3	-174.5

The unit step response of the system approaches a steady state value of _____.

Q.49

A zero mean white Gaussian noise having power spectral density $\frac{N_0}{2}$ is passed through an LTI filter whose impulse response $h(t)$ is shown in the figure. The variance of the filtered noise at $t = 4$ is

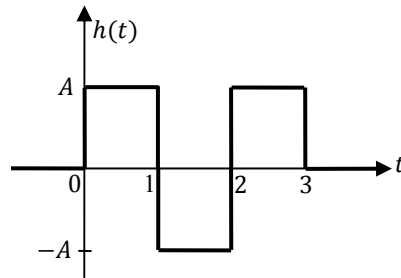

(A) $\frac{3}{2} A^2 N_0$

(B) $\frac{3}{4} A^2 N_0$

(C) $A^2 N_0$

(D) $\frac{1}{2} A^2 N_0$

Q.50

$\{X_n\}_{n=-\infty}^{\infty}$ is an independent and identically distributed (i.i.d.) random process with X_n equally likely to be $+1$ or -1 . $\{Y_n\}_{n=-\infty}^{\infty}$ is another random process obtained as $Y_n = X_n + 0.5 X_{n-1}$. The autocorrelation function of $\{Y_n\}_{n=-\infty}^{\infty}$, denoted by $R_Y[k]$, is

(A)

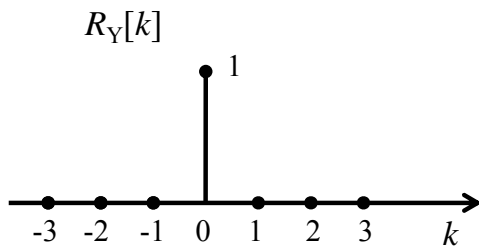

(B)

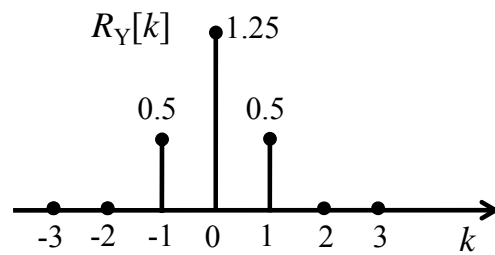

(C)

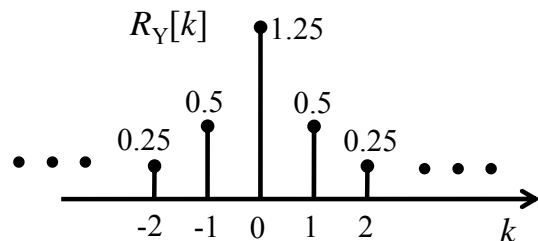

(D)

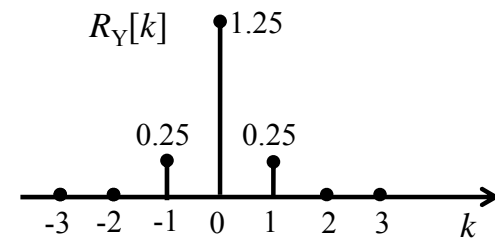

Q.51 Consider a binary, digital communication system which uses pulses $g(t)$ and $-g(t)$ for transmitting bits over an AWGN channel. If the receiver uses a matched filter, which one of the following pulses will give the minimum probability of bit error?

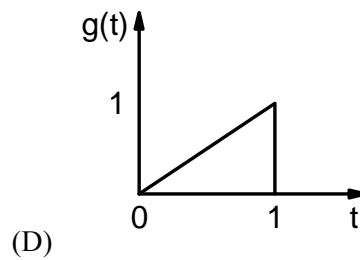
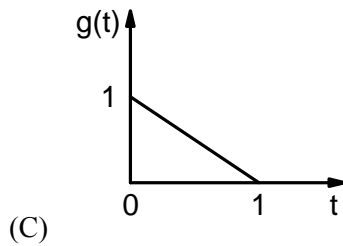
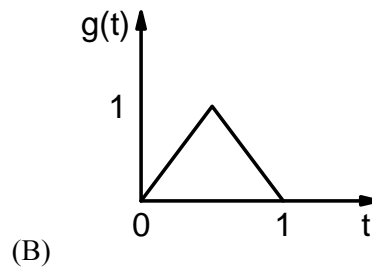
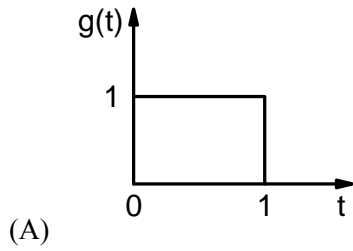

Q.52 Let $X \in \{0,1\}$ and $Y \in \{0,1\}$ be two independent binary random variables. If $P(X = 0) = p$ and $P(Y = 0) = q$, then $P(X + Y \geq 1)$ is equal to

- (A) $pq + (1 - p)(1 - q)$
- (C) $p(1 - q)$

- (B) pq
- (D) $1 - pq$

Q.53 An air-filled rectangular waveguide of internal dimensions a cm \times b cm ($a > b$) has a cutoff frequency of 6 GHz for the dominant TE_{10} mode. For the same waveguide, if the cutoff frequency of the TM_{11} mode is 15 GHz, the cutoff frequency of the TE_{01} mode in GHz is _____.

Q.54 Two half-wave dipole antennas placed as shown in the figure are excited with sinusoidally varying currents of frequency 3 MHz and phase shift of $\pi/2$ between them (the element at the origin leads in phase). If the maximum radiated E-field at the point P in the x - y plane occurs at an azimuthal angle of 60° , the distance d (in meters) between the antennas is _____.

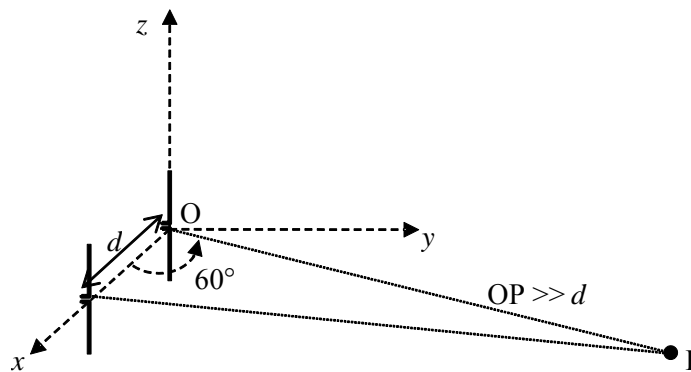

- Q.55 The electric field of a plane wave propagating in a lossless non-magnetic medium is given by the following expression

$$\mathbf{E}(z, t) = \mathbf{a}_x 5 \cos(2\pi \times 10^9 t + \beta z) + \mathbf{a}_y 3 \cos\left(2\pi \times 10^9 t + \beta z - \frac{\pi}{2}\right)$$

The type of the polarization is

- (A) Right Hand Circular. (B) Left Hand Elliptical.
(C) Right Hand Elliptical. (D) Linear.

END OF THE QUESTION PAPER